KATALOG PROFILI
STANDARDOWYCH

CATALOGUE OF STANDARD
PROFILES

ALIPLAST STANDARD
PROFILENVERZEICHNIS

Spis treści | Contents | Inhalt

1. Profile standardowe | Standard profiles | Standardprofile

- 1.1. Kątowniki równoramienne | Equal - L profiles | Winkelprofile Gleichschenklig | 03
- 1.2. Kątowniki nierównoramienne | Non equal - L profiles | Winkelprofile Ungleichschenklig | 04
- 1.3. Ceowniki | U-profiles | U-profile | 06
- 1.4. Rury okrągłe | Round tubes | Rundrohre | 08
- 1.5. Rury kwadratowe | Square tubes | Quadratrohre | 10
- 1.6. Rury prostokątne | Rectangular tubes | Vierkantrohre | 11
- 1.7. Pręty prostokątne | Flat bars | Flachprofile | 14
- 1.8. Pręty okrągłe | Round bars | Rundstangen | 16
- 1.9. Pręty kwadratowe | Square bars | Vierkantstange | 16
- 1.10. Teowniki | T-profiles | T-profile | 17

2. Profile specjalne | Special sections | Sonderprofile

- 2.1. Profile reklamowe | Profiles for advertising | Profile für die Lichtwerbung | 18
- 2.2. Profile do płyt poliwęglanowych | Profiles for polycarbonates | Profile zu Konstruktionen mit Polykarbonat | 20
- 2.3. Profile do central klimatyzacyjnych | Profiles for air conditioning | Klimazentralenprofile | 21
- 2.4. Profile do zabudów samochodowych | Profiles for trailers, semi-trailers | Fahrzeugbauprofile | 22
- 2.5. Profile elewacyjne | Elevation profiles | Elevationsprofile | 23
- 2.6. Profile fotowoltaiczne | Profiles for photovoltaics | Profile für die photovoltaik | 24
- 2.7. Profile do hal namiotowych | Profiles for tents | Zeltbauprofile | 25
- 2.8. Profile inne | Other profiles | Andere Profile | 25

1. Profile standardowe | Standard profiles | Standardprofile

1.1. Kątowniki równoramienne

Equal - L profiles
Winkelprofile Gleichschenklig

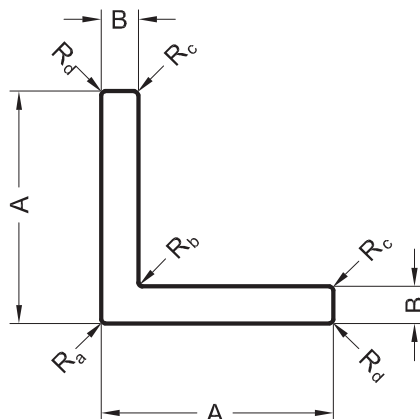

Lp.	Wymiar Dimension Abmessung		Promień Radius Radius				Obwód Perimeter Abwicklung	Masa Weight Gewicht	Nr matrycy Number of die Werkzeug Nr.
	A	B	Ra	Rb	Rc	Rd	mm	kg/m	
1	20	1,5	0,5	0,5	0,3	0,3	79,06	0,156	M1.90276
2	20	2	0,2	0,2	0,2	0,2	79,50	0,205	M1.90078
3	25	1,5	0,3	0,3	0,3	0,3	99,23	0,196	M1.90105
4	25	2	0,3	0,3	0,3	0,3	99,23	0,259	M1.90020
5	25	3	0,3	0,3	0,3	0,3	99,23	0,380	M1.90328
6	30	2	0,2	0,2	0,2	0,2	119,49	0,313	M1.90002
7	30	3	0,5	0,5	0,5	0,5	118,71	0,461	M1.90019
8	35	2	0,3	0,3	0,3	0,3	139,23	0,367	M1.90094
9	35	3	0,5	0,5	0,5	0,5	138,71	0,544	M1.90062
10	40	2	0,2	0,2	0,2	0,2	159,49	0,421	M1.90003
11	40	3	0,5	0,5	0,5	0,5	158,71	0,623	M1.90162
12	40	4	0,5	0,5	0,5	0,5	158,71	0,820	M1.90199
13	50	2	0,3	0,3	0,3	0,3	199,23	0,529	M1.90004
14	50	3	0,3	0,3	0,3	0,3	199,23	0,788	M1.90070
15	50	5	0,5	0,5	0,5	0,5	198,93	1,282	M1.90005
16	60	2	0,5	0,5	0,5	0,5	238,71	0,637	M1.90171
17	60	3	0,3	0,3	0,3	0,3	239,23	0,947	M1.90375
18	100	2	0,3	0,3	0,3	0,3	399,23	1,069	M1.90274
19	100	6	0,6	0,6	0,6	0,6	398,46	3,142	M1.90175

1. Profile standardowe | Standard profiles | Standardprofile

1.2. Kątowniki nierównoramienne

Non equal - L profiles

Winkelprofile Ungleichschenkelig

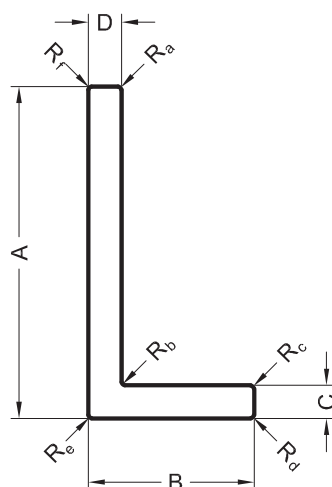

Lp.	Wymiar Dimension Abmessung				Promień Radius Radius						Obwód Perimeter Abwicklung	Masa Weight Gewicht	Nr matrycy Number of die Werkzeug Nr.
	A	B	C	D	Ra	Rb	Rc	Rd	Re	Rf	mm	kg/m	
1	30	20	1,5	1,5	0,3	0,3	0,3	0,3	0,3	0,3	99,23	0,196	M1.90337
2	30	20	2	2	0,5	0,5	0,5	0,5	0,5	0,5	98,71	0,259	M1.90055
3	30	20	4	4	0,3	0,3	0,3	0,3	0,3	0,3	99,23	0,497	M1.90423
4	35	25	3	3	0,3	0,3	0,3	0,3	0,3	0,3	119,23	0,462	M1.90120
5	40	10	2	2	0,5	0,5	0,5	0,5	0,5	0,5	98,71	0,259	M1.90371
6	40	18	5	5	0,5	0,5	0,5	0,5	0,5	0,5	114,71	0,715	M1.90206
7	40	20	2	2	0,5	0,5	0,5	0,5	0,5	0,5	118,71	0,313	M1.90009
8	40	25	2	2	0,2	0,2	0,2	0,2	0,2	0,2	129,49	0,340	M1.90298
9	40	25	3	3	0,5	0,5	0,5	0,5	0,5	0,5	128,71	0,504	M1.90063
10	40	30	3	3	0,5	0,5	0,5	0,5	0,5	0,5	138,71	0,542	M1.90088
11	50	20	2	2	0,5	0,5	0,5	0,5	0,5	0,5	138,71	0,367	M1.90079
12	50	25	2	2	0,3	0,5	0,3	0,3	0,5	0,3	149,06	0,394	M1.90357
13	50	30	2	2	0,3	0,3	0,3	0,3	0,3	0,3	159,23	0,421	M1.90397
14	60	20	2	2	0,3	0,3	0,3	0,3	0,3	0,3	159,23	0,421	M1.90286
15	60	30	2	2	0,3	0,5	0,3	0,3	0,5	0,3	179,06	0,475	M1.90356
16	60	30	10	10	1,5	1,5	1,5	1,5	1,5	1,5	176,14	2,155	M1.90348
17	60	40	2	2	0,5	0,5	0,5	0,5	0,5	0,5	198,71	0,529	M1.90198
18	60	40	3	3	0,6	0,6	0,6	0,6	0,6	0,6	198,46	0,785	M1.90257
19	60	40	5	5	0,6	0,6	0,6	0,6	0,6	0,6	198,46	1,282	M1.90124
20	60	45	1,8	1,8	0,3	0,3	0,3	0,3	0,3	0,3	209,23	0,501	M1.90129

1. Profile standardowe | Standard profiles | Standardprofile

1.2. Kątowniki nierównoramienne

Non equal - L profiles

Winkelprofile Ungleichschenkelig

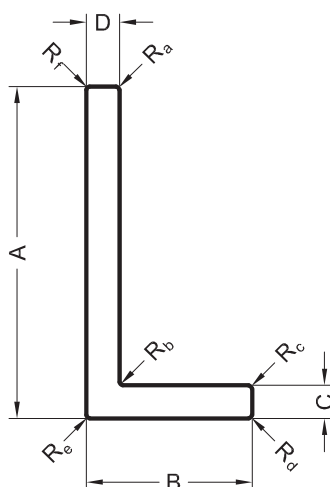

Lp.	Wymiar Dimension Abmessung				Promień Radius Radius						Obwód Perimeter Abwicklung	Masa Weight Gewicht	Nr matrycy Number of die Werkzeug Nr.
	A	B	C	D	Ra	Rb	Rc	Rd	Re	Rf	mm	kg/m	
21	60	50	3	3	0,6	0,6	0,6	0,6	0,6	0,6	218,46	0,866	M1.90234
22	65	25	2	2	0,4	0,4	0,4	0,4	0,4	0,4	178,97	0,475	M1.90398
23	65	40	3	3	0,6	0,6	0,6	0,6	0,6	0,6	208,46	0,825	M1.90148
24	80	20	2	2	0,5	0,5	0,5	0,5	0,5	0,5	198,71	0,529	M1.90394
25	80	40	1,8	1,8	0,3	0,3	0,3	0,3	0,3	0,3	239,23	0,574	M1.90362
26	80	40	2	2	0,3	0,3	0,3	0,3	0,3	0,3	239,23	0,637	M1.90407
27	80	40	3	3	0,5	0,5	0,5	0,5	0,5	0,5	238,71	0,947	M1.90304
28	80	40	4	4	0,5	0,5	0,5	0,5	0,5	0,5	238,71	1,252	M1.90170
29	80	50	3	3	0,6	0,6	0,6	0,6	0,6	0,6	258,46	1,028	M1.90235
30	80	50	6	6	0,5	0,5	0,5	0,5	0,5	0,5	258,71	2,008	M1.90176
31	100	50	3	3	0,6	0,6	0,6	0,6	0,6	0,6	298,46	1,190	M1.90142
32	100	50	6	6	0,6	0,6	0,6	0,6	0,6	0,6	298,46	2,332	M1.90316
33	100	60	2	2	0,5	0,5	0,5	0,5	0,5	0,5	318,71	0,853	M1.90205
34	120	50	3	3	0,6	0,6	0,6	0,6	0,6	0,6	338,46	1,352	M1.90143
35	140	50	3	3	0,6	0,6	0,6	0,6	0,6	0,6	378,46	1,514	M1.90144
36	160	50	3	3	0,6	0,6	0,6	0,6	0,6	0,6	418,46	1,676	M1.90145
37	180	50	3	3	0,6	0,6	0,6	0,6	0,6	0,6	458,46	1,838	M1.90086
38	200	50	3	3	0,6	0,6	0,6	0,6	0,6	0,6	498,46	2,000	M1.90236
39	220	50	3	3	0,6	0,6	0,6	0,6	0,6	0,6	538,46	2,162	M1.90237

1. Profile standardowe | Standard profiles | Standardprofile

1.3. Ceowniki

U-profiles

U-profile

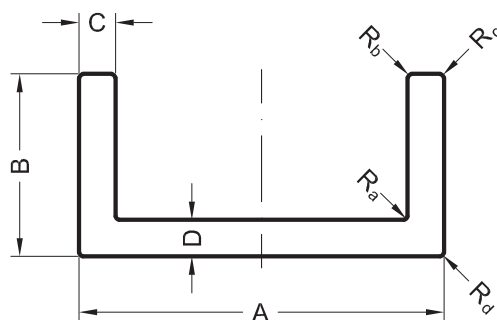

Lp.	Wymiar Dimension Abmessung				Promień Radius Radius				Obwód Perimeter Abwicklung	Masa Weight Gewicht	Nr matrycy Number of die Werkzeug Nr.
	A	B	C	D	Ra	Rb	Rc	Rd	mm	kg/m	
1	15	15	1,5	1,5	0,3	0,3	0,3	0,3	85,97	0,170	M1.90112
2	15	20	2	2	0,3	0,3	0,3	0,3	104,970	0,275	M1.90364
3	16	30	2	2	0,3	0,3	0,3	0,3	146,97	0,389	M1.90363
4	18	18	2	2	0,3	0,3	0,3	0,3	102,97	0,270	M1.90294
5	20	20	1,5	1,5	0,3	0,3	0,3	0,3	115,97	0,231	M1.90367
6	20	20	2	2	0,3	0,3	0,3	0,3	114,97	0,302	M1.90111
7	20	20	3	3	0,2	0,2	0,2	0,2	113,31	0,437	M1.90303
8	20	30	2	2	0,3	0,3	0,3	0,3	154,97	0,410	M1.90319
9	21	20	1,4	1,4	0,3	0,3	0,3	0,3	118,17	0,220	M1.90293
10	22	22	2	2	0,3	0,3	0,3	0,3	126,97	0,335	M1.90412
11	25	15	2	2	0,3	0,3	0,3	0,3	104,97	0,275	M1.90291
12	30	23	1,7	1,7	0,5	0,5	0,5	0,5	146,88	0,333	M1.90347
13	30	30	3	3	3	0,75	0,75	0,75	169,49	0,689	M1.90195
14	30	40	2,5	3	0,5	0,2	0,2	0,2	213,06	0,743	M1.90099
15	34	50	3	3	0,5	0,5	0,5	0,5	260,28	1,036	M1.90241
16	40	20	2	2	0,3	0,3	0,3	0,3	154,97	0,410	M1.90401
17	40	30	3	3	0,5	0,5	0,5	0,5	192,28	0,761	M1.90334
18	40	40	2	2	0,3	0,3	0,3	0,3	234,97	0,626	M1.90093
19	40	40	4	4	0,6	0,6	0,6	0,6	229,94	1,209	M1.90095
20	40	50	2,5	2,5	0,5	0,5	0,5	0,5	273,28	0,911	M1.90014
21	45	25	2,5	2,5	0,2	0,5	0,5	0,5	183,54	0,607	M1.90343
22	50	25	3	3	0,5	0,5	0,5	0,5	192,28	0,761	M1.90391
23	50	30	3	3	1,5	1	1	1	210,14	0,842	M1.90264

1. Profile standardowe | Standard profiles | Standardprofile

1.3. Ceowniki

U-profiles

U-profile

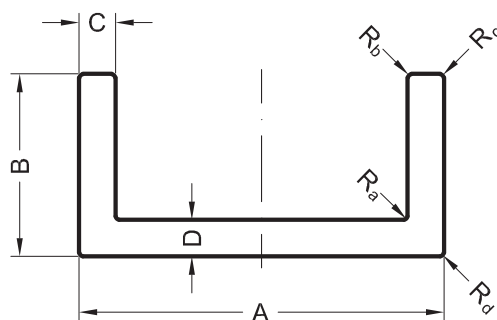

Lp.	Wymiar Dimension Abmessung				Promień Radius Radius				Obwód Perimeter Abwicklung mm	Masa Weight Gewicht kg/m	Nr matrycy Number of die Werkzeug Nr.
	A	B	C	D	Ra	Rb	Rc	Rd			
24	50	50	3	3	0,4	0,4	0,4	0,4	292,63	1,166	M1.90366
25	50	30	4	4	0,5	0,5	0,5	0,5	210,28	1,101	M1.90226
26	50	40	4	4	0,5	0,5	0,5	0,5	250,28	1,317	M1.90010
27	50	45	2	2	0,5	0,5	0,5	0,5	274,28	0,734	M1.90011
28	50	50	5	5	0,5	0,5	0,5	0,5	288,28	1,889	M1.90227
29	60	20	2	2	0,3	0,3	0,3	0,3	194,97	0,518	M1.90287
30	60	40	3	3	0,3	0,3	0,3	0,3	272,97	1,085	M1.90300
31	60	40	5	5	0,6	0,6	0,6	0,6	267,94	1,754	M1.90177
32	65	40	6	6	0,5	0,5	0,5	0,5	276,28	2,154	M1.90342
33	79	34	3,5	3,5	0,5	0,5	0,5	0,5	285,28	1,322	M1.02747
34	80	40	5	5	0,6	0,6	0,6	0,6	307,94	2,024	M1.90258
35	80	45	6	6	0,5	0,5	0,5	0,5	326,28	2,559	M1.90279
36	86	40	3	4	0,5	0,5	0,5	0,5	322,28	1,511	M1.90244
37	100	50	5	5	0,5	0,5	0,5	0,5	388,28	2,564	M1.90228
38	100	50	10	10	10	5	0,2	0,2	366,47	4,947	M1.90085
39	108	60	5	5	0,5	0,5	0,5	0,5	444,30	2,942	M1.90108
40	120	45	3	3	0,6	0,6	0,6	0,6	411,94	1,652	M1.90147
41	120	60	5	5	0,7	0,2	0,2	0,7	468,45	3,105	M1.90123
42	120	60	8	8	0,7	0,2	0,2	0,7	462,46	4,838	M1.90122
43	120	70	5	5	0,5	0,5	0,5	0,5	508,30	3,375	M1.90109
44	125	80	8	8	0,8	0,8	0,8	0,8	551,25	5,809	M1.90351
45	160	80	3	2	2	1	1	4	629,13	2,111	M1.90272

1. Profile standardowe | Standard profiles | Standardprofile

1.4. Rury okrągłe

Round tubes

Rundrohre

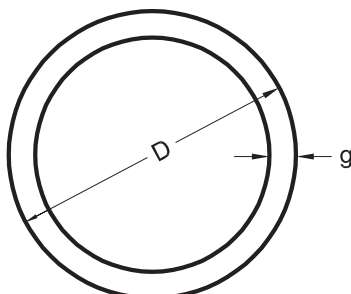

Lp.	Wymiar Dimension Abmessung		Obwód Perimeter Abwicklung mm	Masa Weight Gewicht kg/m	Nr matrycy Number of die Werkzeug Nr.
	D	g			
1	16	1,5	50,27	0,184	M1.90240
2	16	2	50,27	0,238	M1.90061
3	18	1,5	56,55	0,210	M1.90084
4	19,6	1,3	61,58	0,202	M1.90033
5	20	1	62,83	0,161	M1.90163
6	20	1,5	62,83	0,235	M1.90185
7	20	2	62,83	0,305	M1.90050
8	22	2	69,12	0,339	M1.90091
9	22	2	69,12	0,339	M1.90417
10	22,5	1,2	70,69	0,217	M1.90032
11	22,5	1,5	70,69	0,267	M1.90150
12	25	1,5	78,54	0,299	M1.90110
13	25	2	78,54	0,390	M1.90047
14	27,2	1,1	85,45	0,244	M1.90383
15	28	1	87,97	0,229	M1.90186
16	28	1,5	87,97	0,337	M1.90141
17	28	2	87,97	0,441	M1.90378
18	28	2,5	87,97	0,541	M1.90034
19	28	5	87,97	0,975	M1.90321
20	28,6	2	89,85	0,451	M1.90380

Lp.	Wymiar Dimension Abmessung		Obwód Perimeter Abwicklung mm	Masa Weight Gewicht kg/m	Nr matrycy Number of die Werkzeug Nr.
	D	g			
21	28,6	3	89,85	0,651	M1.90204
22	30	1,5	94,25	0,362	M1.90087
23	30	2	94,25	0,477	M1.90069
24	30	3	94,25	0,687	M1.90290
25	32	1	100,53	0,263	M1.90107
26	32	2	100,53	0,509	M1.90277
27	32	3	100,53	0,738	M1.90178
28	34	1,5	106,81	0,414	M1.90231
29	35	1,5	109,96	0,426	M1.90021
30	35	2	109,96	0,560	M1.90015
31	35	3	109,96	0,814	M1.90149
32	35,15	4,5	110,43	1,170	M1.90159
33	40	1,5	125,66	0,490	M1.90022
34	40	2	125,66	0,645	M1.90042
35	40	2,5	125,66	0,795	M1.90239
36	40	3	125,66	0,942	M1.90289
37	42	1,5	131,95	0,515	M1.90230
38	42	3,8	131,95	1,231	M1.90215
39	43	6,75	135,09	2,076	M1.90255
40	45	2	141,37	0,729	M1.90424

1. Profile standardowe | Standard profiles | Standardprofile

1.4. Rury okrągłe

Round tubes

Rundrohre

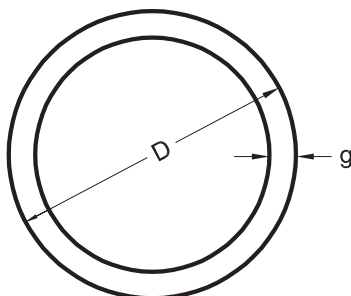

Lp.	Wymiar Dimension Abmessung		Obwód Perimeter Abwicklung mm	Masa Weight Gewicht kg/m	Nr matrycy Number of die Werkzeug Nr.
	D	g			
41	48	3	150,80	1,145	M1.90283
42	48,3	3,3	151,74	1,260	M1.90267
43	48,3	4	151,74	1,503	M1.90151
44	48,3	6	151,74	2,153	M1.90209
45	50	1,5	157,08	0,617	M1.90040
46	50	2	157,08	0,814	M1.90059
47	50	3	157,08	1,196	M1.90049
48	50	4	157,08	1,561	M1.90288
49	50	5	157,08	1,909	M1.90208
50	50	10	157,08	3,393	M1.90338
51	58	2	182,21	0,950	M1.90229
52	60	1,5	188,49	0,744	M1.90048
53	60	2	188,49	0,984	M1.90242
54	60	3	188,49	1,450	M1.90243
55	60	3,5	188,49	1,677	M1.90410
56	60	4	188,49	1,900	M1.90164
57	60	5	188,49	2,333	M1.90224
58	61	6	191,64	2,799	M1.90345
59	70	2	219,91	1,154	M1.90039
60	71	2	223,10	1,170	M1.00316

Lp.	Wymiar Dimension Abmessung		Obwód Perimeter Abwicklung mm	Masa Weight Gewicht kg/m	Nr matrycy Number of die Werkzeug Nr.
	D	g			
61	75	3,5	235,62	2,123	M1.90161
62	80	3	251,33	1,959	M1.90101
63	82	11	257,61	6,625	M1.90346
64	85	2	267,10	1,408	M1.00317
65	87,5	2	274,89	1,450	M1.90196
66	90	2	282,74	1,493	M1.90332
67	90	2,5	282,74	1,856	M1.90333
68	100	2	314,16	1,663	M1.90301
69	102	3	320,44	2,519	M1.90374
70	103,5	2	325,16	1,722	M1.90197
71	109	5	342,44	4,411	M1.00312
72	120	3	376,99	2,977	M1.90247
73	120	5	376,99	4,877	M1.90249
74	121	11	380,13	10,264	M1.00313
75	140	3	439,82	3,486	M1.90404
76	149	4,5	468,10	5,516	M1.90167
77	150	5	471,24	6,150	M1.90248
78	150	6	471,24	7,329	M1.90251
79	182	4,8	571,77	7,215	M1.90168

1. Profile standardowe | Standard profiles | Standardprofile

1.5. Rury kwadratowe

Square tubes
Quadratrohre

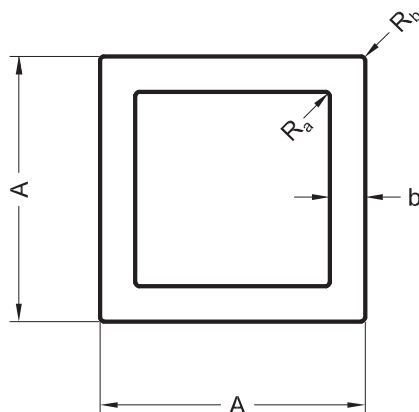

Lp.	Wymiar Dimension Abmessung		Promień Radius Radius		Obwód Perimeter Abwicklung	Masa Weight Gewicht	Nr matrycy Number of die Werkzeug Nr.
	A	b	Ra	Rb	mm	kg/m	
1	20	1,5	0,3	0,5	79,14	0,299	M1.90219
2	20	2	0,5	0,5	79,14	0,389	M1.90041
3	20	2	1	3	74,85	0,370	M1.90269
4	21,5	1,5	1	1	84,28	0,324	M1.90173
5	22	2	0,5	0,5	87,14	0,432	M1.90083
6	25	1	0,5	0,5	99,14	0,259	M1.90137
7	25	1,4	0,3	0,3	99,49	0,357	M1.90098
8	25	2	0,5	0,5	99,14	0,497	M1.90157
9	30	2	0,5	0,5	119,14	0,605	M1.90023
10	30	3	0,5	0,5	119,14	0,875	M1.90024
11	35	2	0,3	0,5	139,14	0,712	M1.90092
12	40	2	0,5	0,5	159,14	0,821	M1.90025
13	40	3	0,5	0,5	159,14	1,203	M1.90072
14	40	4	0,5	0,5	159,14	1,556	M1.90046
15	45	2,5	0,3	0,5	179,14	1,147	M1.90256
16	50	2	0,5	0,5	199,14	1,037	M1.90051
17	50	3	0,5	0,5	199,14	1,523	M1.90116
18	50	5	0,5	0,5	199,14	2,430	M1.90225
19	60	1,2	0,5	0,5	239,14	0,765	M1.90073
20	60	2	0,5	0,5	239,14	1,253	M1.90026

Lp.	Wymiar Dimension Abmessung		Promień Radius Radius		Obwód Perimeter Abwicklung	Masa Weight Gewicht	Nr matrycy Number of die Werkzeug Nr.
	A	b	Ra	Rb	mm	kg/m	
21	60	2	1	3	234,85	1,234	M1.90295
22	60	3	0,6	0,6	238,97	1,847	M1.90052
23	70	2	2	4	273,13	1,441	M1.90296
24	80	2	0,5	0,5	319,14	1,685	M1.90416
25	80	2	2	4	313,13	1,657	M1.90297
26	80	3	1	1	318,28	2,495	M1.90194
27	80	6	0,5	1	318,28	4,793	M1.90202
28	100	3	0,5	0,5	399,14	3,154	M1.02944
29	100	4	0,5	0,5	399,14	4,147	M1.90299
30	110	3	0,5	1	438,28	3,465	M1.90382
31	120	5	1	1	478,28	6,210	M1.90373
32	150	5	1	1	598,28	7,830	M1.90315

1. Profile standardowe | Standard profiles | Standardprofile

1.6. Rury prostokątne

Rectangular tubes
Vierkantrohre

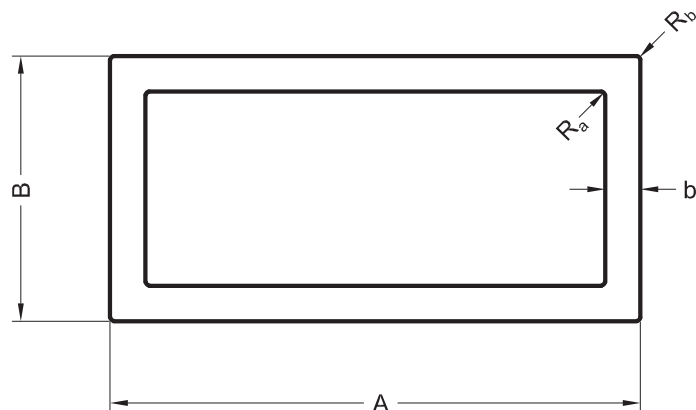

Lp.	Wymiar Dimension Abmessung			Promień Radius Radius		Obwód Perimeter Abwicklung	Masa Weight Gewicht	Nr matrycy Number of die Werkzeug Nr.
	A	B	b	Ra	Rb	mm	kg/m	
1	15	10	1,5	1	2,5	45,71	0,166	M1.90268
2	20	10	1,5	0,3	0,2	59,49	0,219	M1.90102
3	20	15	2	0,3	0,3	69,49	0,335	M1.90353
4	25	15	1,5	0,3	0,3	79,49	0,300	M1.90259
5	25	15	2	0,3	0,3	79,49	0,389	M1.90220
6	30	10	2	0,3	0,4	79,31	0,389	M1.90361
7	30	15	2	0,3	0,5	89,14	0,442	M1.90402
8	30	20	1	0,2	0,3	99,49	0,259	M1.90273
9	30	20	1	2,5	3,5	94,00	0,245	M1.90038
10	30	20	2	0,5	0,5	99,14	0,496	M1.90007
11	30	25	2	0,2	0,3	109,49	0,551	M1.90310
12	35	20	2	0,3	0,3	109,49	0,551	M1.90395
13	35	25	2	0,3	0,3	119,50	0,605	M1.90370
14	36	18	3	0,5	0,5	107,14	0,778	M1.90405
15	40	20	1,2	2,3	3,5	114,00	0,357	M1.90127
16	40	20	1,5	0,3	0,5	119,14	0,461	M1.90411
17	40	20	2	0,5	0,5	119,14	0,604	M1.90006
18	40	25	2	0,3	0,5	129,14	0,658	M1.90246
19	40	30	2	0,5	0,5	139,14	0,713	M1.90139
20	40	30	3	0,3	0,3	139,49	1,037	M1.90327

1. Profile standardowe | Standard profiles | Standardprofile

1.6. Rury prostokątne

Rectangular tubes
Vierkantrohre

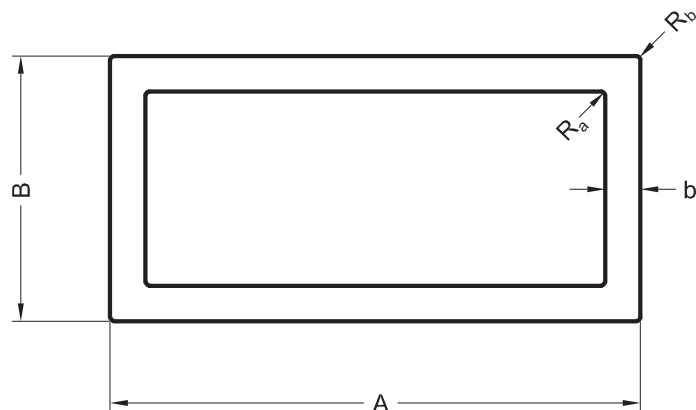

Lp.	Wymiar Dimension Abmessung			Promień Radius Radius		Obwód Perimeter Abwicklung	Masa Weight Gewicht	Nr matrycy Number of die Werkzeug Nr.
	A	B	b	Ra	Rb	mm	kg/m	
21	50	15	2	2	2	126,57	0,659	M1.90128
22	50	20	2	0,3	0,5	139,14	0,713	M1.90027
23	50	25	2	0,3	0,5	149,14	0,766	M1.90307
24	50	30	2	0,3	0,5	159,14	0,821	M1.90028
25	50	30	3	0,3	0,5	159,14	1,198	M1.90313
26	50	30	4	0,5	0,5	159,14	1,561	M1.90071
27	50	40	2	0,5	0,5	179,14	0,929	M1.90054
28	60	20	2	0,5	0,5	159,14	0,820	M1.90281
29	60	30	2	0,5	0,5	179,14	0,928	M1.90016
30	60	30	2	1	3	174,85	0,910	M1.90060
31	60	30	2,5	0,5	0,5	179,14	1,148	M1.90140
32	60	30	3	0,5	0,5	179,57	1,361	M1.90408
33	60	40	2	0,3	0,5	199,14	1,037	M1.90029
34	60	40	3	0,5	0,5	199,14	1,523	M1.90053
35	60	40	4	0,5	0,5	199,14	1,987	M1.90354
36	70	50	2	0,5	0,5	239,14	1,253	M1.90169
37	80	20	2	0,5	0,5	199,14	1,037	M1.90365
38	80	30	3	1,5	4	213,13	1,653	M1.90125
39	80	40	2	0,3	0,5	239,14	1,252	M1.90379
40	80	40	2,5	0,5	0,5	239,14	1,553	M1.90030

1. Profile standardowe | Standard profiles | Standardprofile

1.6. Rury prostokątne

Rectangular tubes

Vierkantrohre

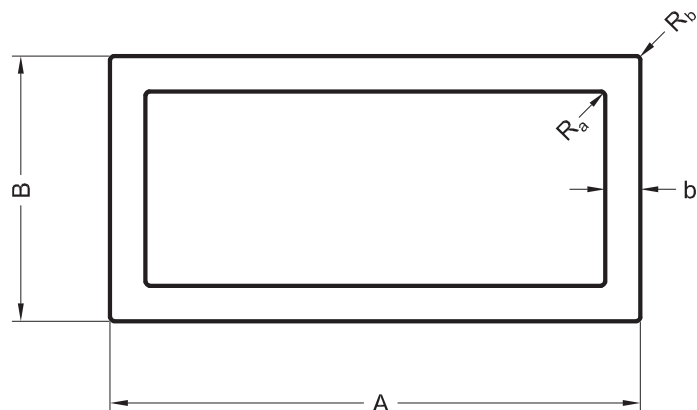

Lp.	Wymiar Dimension Abmessung			Promień Radius Radius		Obwód Perimeter Abwicklung	Masa Weight Gewicht	Nr matrycy Number of die Werkzeug Nr.
	A	B	b	Ra	Rb	mm	kg/m	
41	80	40	4	1,5	1	238,28	2,422	M1.90263
42	80	50	2	0,3	0,5	259,14	1,360	M1.90282
43	80	60	3	0,5	0,5	279,14	2,179	M1.90075
44	80	60	4	0,6	0,6	278,97	2,851	M1.90392
45	100	20	2	0,5	0,5	239,14	1,253	M1.90106
46	100	40	4	0,5	0,5	279,14	2,851	M1.90409
47	100	50	2	0,3	0,3	299,49	1,577	M1.90326
48	100	50	3	0,3	0,3	299,49	2,333	M1.90325
49	100	60	3	0,6	0,6	318,97	2,495	M1.90080
50	100	60	3	2	5	311,42	2,446	M1.90238
51	100	80	3	0,6	1	358,28	2,817	M1.90393
52	120	20	2	0,6	1	278,28	1,467	M1.90369
53	120	30	2	0,6	1	298,28	1,575	M1.90415
54	120	40	2	0,6	1	318,28	1,683	M1.90427
55	120	60	3	0,6	1	358,28	2,817	M1.90414
56	120	60	6	0,6	0,6	359,00	5,443	M1.90076
57	150	100	4	1	2	496,57	5,220	M1.90425
58	180	40	4	1	1	438,28	4,579	M1.90349
59	200	50	4	0,5	1	498,28	5,225	M1.90284
60	200	100	4	0,6	0,6	598,97	6,307	M1.90320

1. Profile standardowe | Standard profiles | Standardprofile

1.7. Pręty prostokątne

Flat bars
Flachprofile

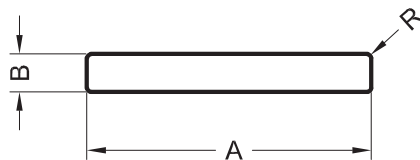

Lp.	Wymiar Dimension Abmessung			Obwód Perimeter Abwicklung	Masa Weight Gewicht	Nr matrycy Number of die Werkzeug Nr.
	A	B	R	mm	kg/m	
1	15	5	0,2	39,66	0,203	M1.90044
2	17	4	0,2	41,66	0,184	M1.90275
3	18	7	0,2	49,66	0,340	M1.90117
4	20	3	0,2	45,70	0,162	M1.90115
5	20	5	0,3	49,49	0,270	M1.90400
6	20	10	0,3	59,49	0,540	M1.90045
7	25	2	0,25	53,57	0,135	M1.90261
8	25	3	0,2	55,66	0,202	M1.90077
9	25	4	0,3	57,49	0,270	M1.90104
10	25	5	0,5	59,14	0,338	M1.90406
11	25	7	0,2	63,66	0,472	M1.90118
12	25	8	0,2	65,66	0,540	M1.90136
13	30	2	0,2	63,67	0,162	M1.90187
14	30	3	0,2	65,66	0,243	M1.90285
15	30	4	0,3	67,49	0,324	M1.90358
16	30	5	0,5	69,14	0,404	M1.90188
17	30	8	0,5	75,14	0,647	M1.90096
18	30	10	0,2	79,66	0,810	M1.90119
19	35	4	0,3	77,49	0,378	M1.90270
20	40	2	0,2	83,67	0,216	M1.90189
21	40	3	1	84,28	0,322	M1.90154
22	40	4	0,3	87,49	0,432	M1.90341
23	40	5	0,3	89,49	0,540	M1.90318
24	40	6	1	90,28	0,646	M1.90399
25	40	8	0,3	95,49	0,864	M1.90245
26	40	10	0,3	99,49	1,080	M1.90317
27	40	20	0,5	119,14	2,116	M1.90156
28	50	2	0,2	103,67	0,270	M1.90190
29	50	3	0,3	105,49	0,405	M1.90308
30	50	5	0,3	109,49	0,675	M1.90323

1. Profile standardowe | Standard profiles | Standardprofile

1.7. Pręty prostokątne

Flat bars
Flachprofile

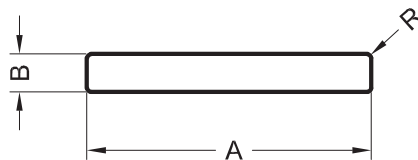

Lp.	Wymiar Dimension Abmessung			Obwód Perimeter Abwicklung	Masa Weight Gewicht	Nr matrycy Number of die Werkzeug Nr.
	A	B	R	mm	kg/m	
31	50	6	0,5	111,14	0,809	M1.90413
32	50	8	0,3	115,49	1,080	M1.90324
33	50	10	0,5	119,14	1,349	M1.90191
34	55	4	0,2	117,66	0,594	M1.90216
35	57	6	0,2	125,66	0,923	M1.90368
36	60	5	0,3	129,49	0,810	M1.90192
37	60	7	1	132,28	1,132	M1.90210
38	60	8	0,2	135,70	1,296	M1.90008
39	60	10	0,3	139,49	1,620	M1.90152
40	60	20	0,5	159,14	3,239	M1.90213
41	70	5	0,3	149,49	0,945	M1.90340
42	70	10	0,5	159,14	1,889	M1.90266
43	72,5	5	0,5	154,14	0,978	M1.90372
44	80	5	0,2	169,66	1,080	M1.90306
45	80	8	0,5	175,14	1,727	M1.90193
46	80	10	0,5	179,14	2,159	M1.90017
47	80	15	0,5	189,14	3,239	M1.90311
48	90	15	0,3	209,49	3,645	M1.90254
49	100	2	0,3	203,49	0,540	M1.90314
50	100	3	0,3	205,49	0,810	M1.90309
51	100	10	0,5	219,14	2,699	M1.90018
52	100	15	0,5	229,14	4,049	M1.90260
53	120	4	0,3	247,49	1,296	M1.90302
54	120	10	0,3	259,49	3,240	M1.90153
55	120	12	0,5	263,14	3,887	M1.90322
56	150	10	0,5	319,14	4,049	M1.90292
57	160	8	0,5	335,14	3,455	M1.90203
58	180	8	2	372,57	3,879	M1.90396
59	180	10	0,5	379,14	4,859	M1.90200
60	195	2,5	1	393,28	1,314	M1.90336

1. Profile standardowe | Standard profiles | Standardprofile

1.8. Pręty okrągłe

Round bars
Rundstangen

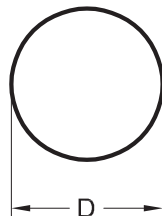

Lp.	Wymiar Dimension Abmessung	Obwód Perimeter Abwicklung	Masa Weight Gewicht	Nr matrycy Number of die Werkzeug Nr.
	D	mm	kg/m	
1	9,6	30,16	0,195	M1.90271
2	10	31,42	0,212	M1.90074
3	14	43,98	0,416	M1.90329
4	16	50,27	0,543	M1.90330
5	18	56,55	0,687	M1.90135
6	25	78,54	1,325	M1.90305
7	26	81,68	1,434	M1.90339
8	28	87,96	1,667	M1.90221
9	30	94,25	1,909	M1.90419
10	35	109,96	2,598	M1.90420
11	40	125,66	3,393	M1.90418
12	50	157,08	5,301	M1.90421

1.9. Pręty kwadratowe

Square bars
Vierkantstange

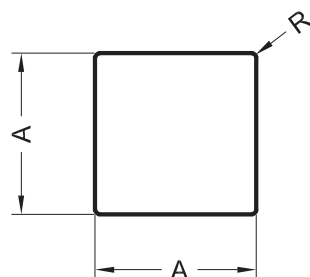

Lp.	Wymiar Dimension Abmessung	R	Obwód Perimeter Abwicklung	Masa Weight Gewicht	Nr matrycy Number of die Werkzeug Nr.
	A x A		mm	kg/m	
1	15 x 15	0,5	59,14	0,607	M1.90201
2	20 x 20	0,5	79,14	1,079	M1.90043
3	30 x 30	0,5	119,14	2,429	M1.90214
4	40 x 40	0,3	159,49	4,320	M1.90166

1. Profile standardowe | Standard profiles | Standardprofile

1.10. Teowniki

T-profiles

T-profile

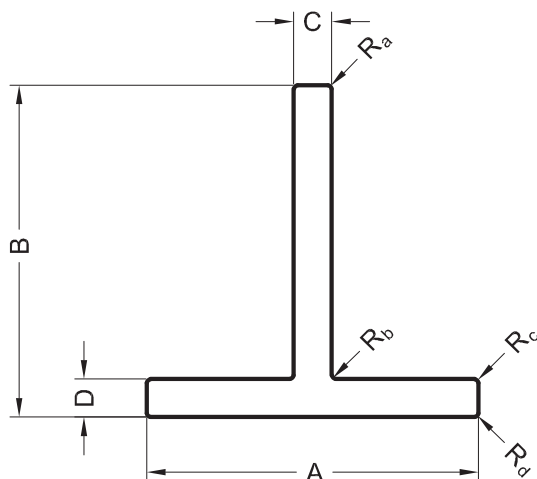

Lp.	Wymiar Dimension Abmessung				Promień Radius Radius				Obwód Perimeter Abwicklung	Masa Weight Gewicht	Nr matrycy Number of die Werkzeug Nr.
	A	B	C	D	Ra	Rb	Rc	Rd	mm	kg/m	
1	60	50	2,5	2,5	0,5	1	0,5	0,5	217,85	0,726	M1.90126
2	65	50	2	2	0,3	0,5	0,3	0,3	228,80	0,611	M1.90056
3	80	43	2,5	2	0,5	0,5	0,5	0,5	244,28	0,711	M1.90064
4	80	43	2,7	2	0,2	1	0,2	0,2	244,63	0,732	M1.90262
5	100	50	2	2	0,5	0,5	0,5	0,5	298,28	0,799	M1.90012
6	110	50	2	2	0,3	1	0,3	0,3	318,37	0,854	M1.90121
7	120	60	2	2	0,3	0,3	0,3	0,3	358,97	0,961	M1.90250

2. Profile specjalne | Special sections | Sonderprofile

2.1. Profile reklamowe

Profiles for advertising | Profile für die Lichtwerbung

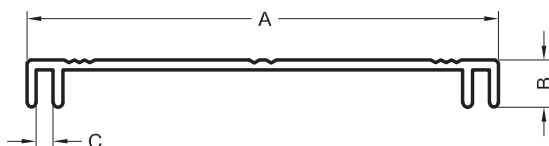

Wymiar Dimension Abmessung	Obwód Perimeter Abwicklung	Masa Weight Gewicht	Nr matrycy Number of die Werkzeug Nr.
A x B x C	mm	kg/m	
100 x 10 x 3,5	267,05	0,627	M1.90037

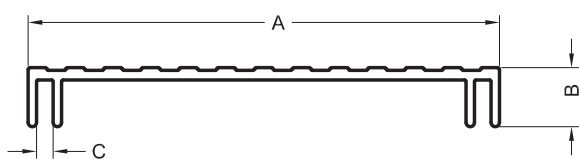

Wymiar Dimension Abmessung	Obwód Perimeter Abwicklung	Masa Weight Gewicht	Nr matrycy Number of die Werkzeug Nr.
A x B x C	mm	kg/m	
100 x 12,5 x 3,5	288,50	0,813	M1.90155

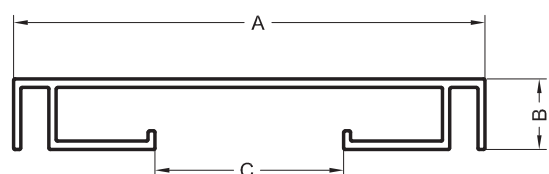

Wymiar Dimension Abmessung	Obwód Perimeter Abwicklung	Masa Weight Gewicht	Nr matrycy Number of die Werkzeug Nr.
A x B x C	mm	kg/m	
100 x 15 x 40	398,91	0,922	M1.90232

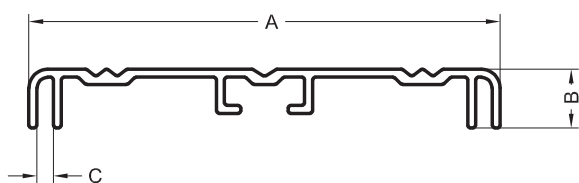

Wymiar Dimension Abmessung	Obwód Perimeter Abwicklung	Masa Weight Gewicht	Nr matrycy Number of die Werkzeug Nr.
A x B x C	mm	kg/m	
100 x 12,5 x 3,5	332,54	0,817	M1.90253

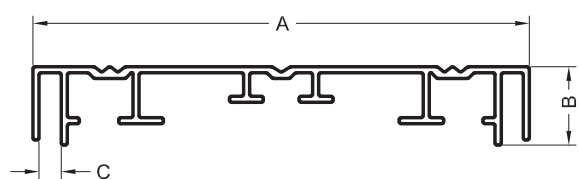

Wymiar Dimension Abmessung	Obwód Perimeter Abwicklung	Masa Weight Gewicht	Nr matrycy Number of die Werkzeug Nr.
A x B x C	mm	kg/m	
139 x 22 x 6,2	610,35	1,553	M1.90172
139 x 22 x 6,2	612,82	1,476	M1.90278

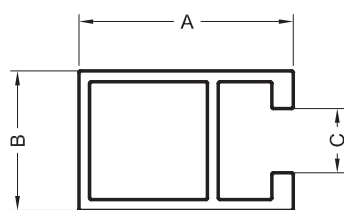

Wymiar Dimension Abmessung	Obwód Perimeter Abwicklung	Masa Weight Gewicht	Nr matrycy Number of die Werkzeug Nr.
A x B x C	mm	kg/m	
30 x 19,5 x 9	133,97	0,437	M1.90146

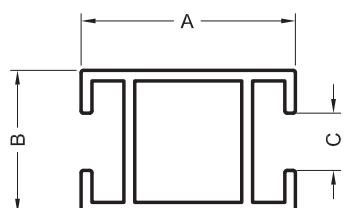

Wymiar Dimension Abmessung	Obwód Perimeter Abwicklung	Masa Weight Gewicht	Nr matrycy Number of die Werkzeug Nr.
A x B x C	mm	kg/m	
30 x 20 x 8	158,45	0,453	M1.90165

2. Profile specjalne | Special sections | Sonderprofile

2.1. Profile reklamowe

Profiles for advertising | Profile für die Lichtwerbung

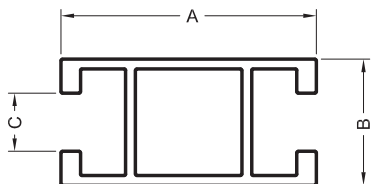

Wymiar Dimension Abmessung	Obwód Perimeter Abwicklung	Masa Weight Gewicht	Nr matrycy Number of die Werkzeug Nr.
A x B x C	mm	kg/m	
39,5 x 19,5 x 9	186,3	0,584	M1.90090

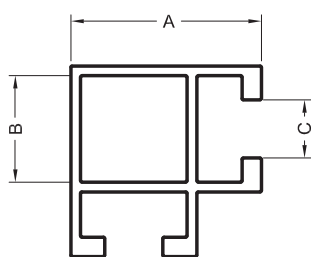

Wymiar Dimension Abmessung	Obwód Perimeter Abwicklung	Masa Weight Gewicht	Nr matrycy Number of die Werkzeug Nr.
A x B x C	mm	kg/m	
29,5 x 16,5 x 9	186,11	0,575	M1.90233

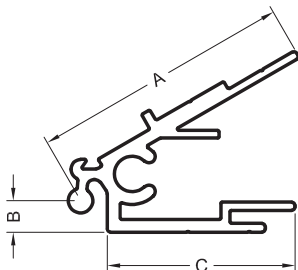

Wymiar Dimension Abmessung	Obwód Perimeter Abwicklung	Masa Weight Gewicht	Nr matrycy Number of die Werkzeug Nr.
A x B x C	mm	kg/m	
40,4 x 4,9 x 29,1	218,67	0,547	M1.90130

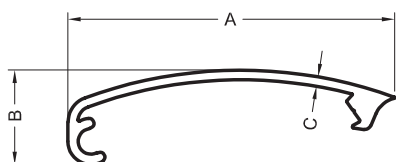

Wymiar Dimension Abmessung	Obwód Perimeter Abwicklung	Masa Weight Gewicht	Nr matrycy Number of die Werkzeug Nr.
A x B x C	mm	kg/m	
50,5 x 14,65 x 1,5	138,91	0,308	M1.90131

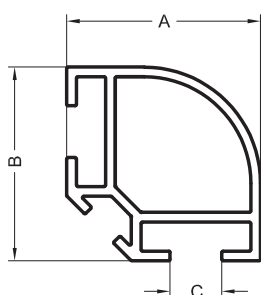

Wymiar Dimension Abmessung	Obwód Perimeter Abwicklung	Masa Weight Gewicht	Nr matrycy Number of die Werkzeug Nr.
A x B x C	mm	kg/m	
30 x 30 x 8	179,18	0,522	M1.90138

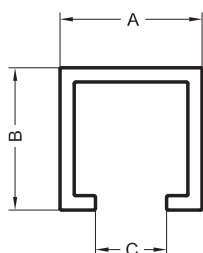

Wymiar Dimension Abmessung	Obwód Perimeter Abwicklung	Masa Weight Gewicht	Nr matrycy Number of die Werkzeug Nr.
A x B x C	mm	kg/m	
20 x 20 x 10	126,97	0,335	M1.90280

2. Profile specjalne | Special sections | Sonderprofile

2.2. Profile do płyt poliwęglanowych

Profiles for polycarbonates | Profile zu Konstruktionen mit Polykarbonat

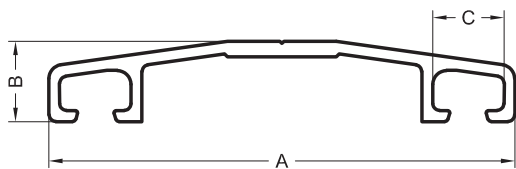

Wymiar Dimension Abmessung	Obwód Perimeter Abwicklung	Masa Weight Gewicht	Nr matrycy Number of die Werkzeug Nr.
A x B x C	mm	kg/m	
60 x 9 x 8	176,50	0,388	M1.90035
60 x 9 x 8	182,18	0,388	M1.90359

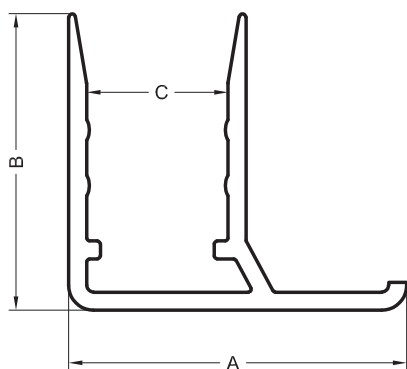

Wymiar Dimension Abmessung	Obwód Perimeter Abwicklung	Masa Weight Gewicht	Nr matrycy Number of die Werkzeug Nr.
A x B x C	mm	kg/m	
20,4 x 21,4 x 6,2	125,70	0,212	M1.90179
22,4 x 21,4 x 8,2	131,70	0,222	M1.90180
24,2 x 21,5 x 10,2	136,13	0,266	M1.90036
24,4 x 21,4 x 10,2	133,88	0,226	M1.90160
30,4 x 21,4 x 16,2	145,60	0,247	M1.90181
34,4 x 21,4 x 20,2	158,89	0,270	M1.90182

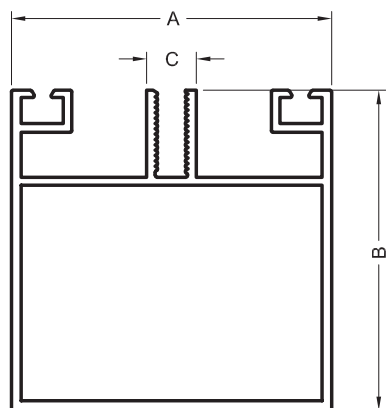

Wymiar Dimension Abmessung	Obwód Perimeter Abwicklung	Masa Weight Gewicht	Nr matrycy Number of die Werkzeug Nr.
A x B x C	mm	kg/m	
60 x 60 x 9,3	433,65	1,419	M1.90089

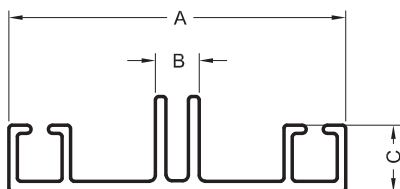

Wymiar Dimension Abmessung	Obwód Perimeter Abwicklung	Masa Weight Gewicht	Nr matrycy Number of die Werkzeug Nr.
A x B x C	mm	kg/m	
60 x 7,8 x 11,9	275,42	0,666	M1.90132
60 x 8 x 12	273,221	0,659	M1.90335

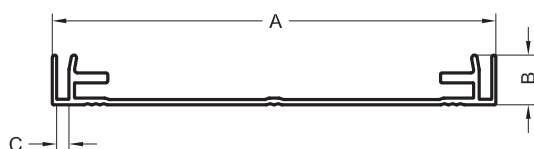

Wymiar Dimension Abmessung	Obwód Perimeter Abwicklung	Masa Weight Gewicht	Nr matrycy Number of die Werkzeug Nr.
A x B x C	mm	kg/m	
160 x 18 x 4,5	495,22	1,390	M1.90350

2. Profile specjalne | Special sections | Sonderprofile

2.3. Profile do central klimatyzacyjnych

Profiles for air conditioning | Klimazentralenprofile

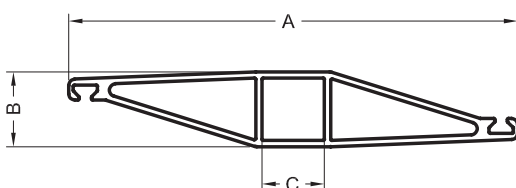
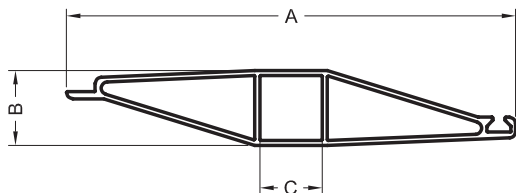
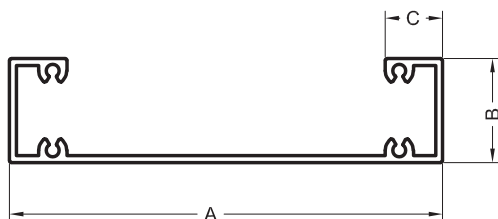
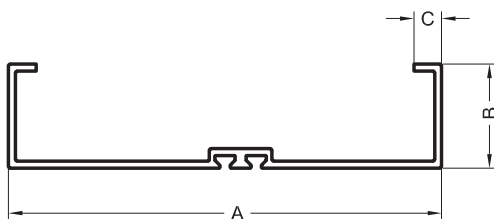
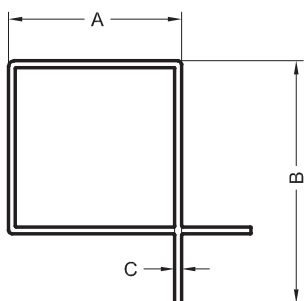
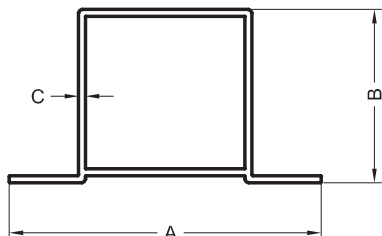

Wymiar Dimension Abmessung	Obwód Perimeter Abwicklung	Masa Weight Gewicht	Nr matrycy Number of die Werkzeug Nr.
A x B x C	mm	kg/m	
70 x 28,5 x 1,5	198,28	0,611	M1.90212
90 x 50 x 2	281,51	1,251	M1.90057
90 x 50 x 1,5	280,68	0,945	M1.90133

Wymiar Dimension Abmessung	Obwód Perimeter Abwicklung	Masa Weight Gewicht	Nr matrycy Number of die Werkzeug Nr.
A x B x C	mm	kg/m	
30 x 50 x 1,5	198,28	0,623	M1.90211
50 x 70 x 2	277,73	1,250	M1.90058
50 x 70 x 1,5	277,21	0,945	M1.90134

Wymiar Dimension Abmessung	Obwód Perimeter Abwicklung	Masa Weight Gewicht	Nr matrycy Number of die Werkzeug Nr.
A x B x C	mm	kg/m	
125 x 30 x 8	416,20	1,127	M1.90081

Wymiar Dimension Abmessung	Obwód Perimeter Abwicklung	Masa Weight Gewicht	Nr matrycy Number of die Werkzeug Nr.
A x B x C	mm	kg/m	
125 x 30 x 16,6	491,43	1,354	M1.90082

Wymiar Dimension Abmessung	Obwód Perimeter Abwicklung	Masa Weight Gewicht	Nr matrycy Number of die Werkzeug Nr.
A x B x C	mm	kg/m	
108 x 18 x 15	237,70	0,823	M1.90100

Wymiar Dimension Abmessung	Obwód Perimeter Abwicklung	Masa Weight Gewicht	Nr matrycy Number of die Werkzeug Nr.
A x B x C	mm	kg/m	
108 x 18 x 15,2	248,20	1,035	M1.90097

2. Profile specjalne | Special sections | Sonderprofile

2.4. Profile do zabudów samochodowych

Profiles for trailers, semi-trailers | Fahrzeugbauprofile

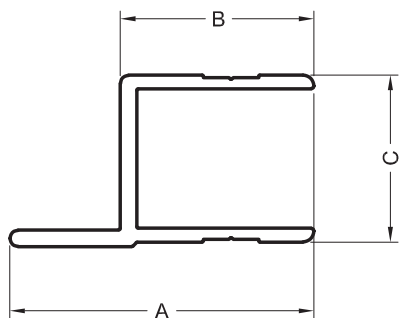

Wymiar Dimension Abmessung	Obwód Perimeter Abwicklung	Masa Weight Gewicht	Nr matrycy Number of die Werkzeug Nr.
A x B x C	mm	kg/m	
55 x 35 x 30,2	233,20	0,811	M1.90065

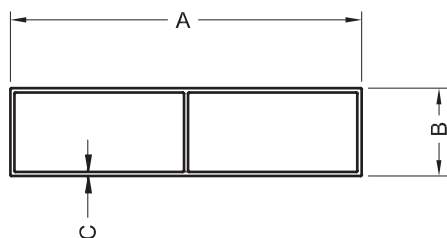

Wymiar Dimension Abmessung	Obwód Perimeter Abwicklung	Masa Weight Gewicht	Nr matrycy Number of die Werkzeug Nr.
A x B x C	mm	kg/m	
100 x 25 x 1,2	246,57	0,860	M1.90066

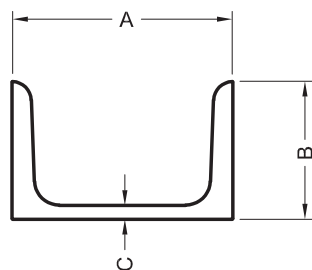

Wymiar Dimension Abmessung	Obwód Perimeter Abwicklung	Masa Weight Gewicht	Nr matrycy Number of die Werkzeug Nr.
A x B x C	mm	kg/m	
80 x 50 x 5	333,90	2,961	M1.90067

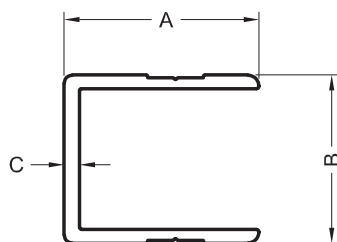

Wymiar Dimension Abmessung	Obwód Perimeter Abwicklung	Masa Weight Gewicht	Nr matrycy Number of die Werkzeug Nr.
A x B x C	mm	kg/m	
35 x 30,2 x 2,8	193,30	0,630	M1.90068

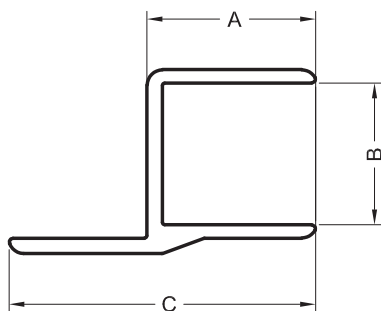

Wymiar Dimension Abmessung	Obwód Perimeter Abwicklung	Masa Weight Gewicht	Nr matrycy Number of die Werkzeug Nr.
A x B x C	mm	kg/m	
22 x 18,5 x 40	162,29	0,423	M1.90158

2. Profile specjalne | Special sections | Sonderprofile

2.4. Profile do zabudów samochodowych

Profiles for trailers, semi-trailers | Fahrzeugbauprofile

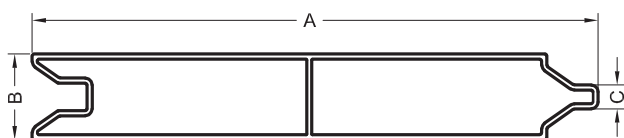
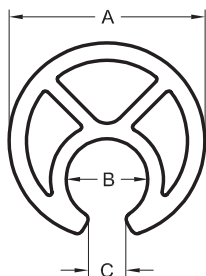
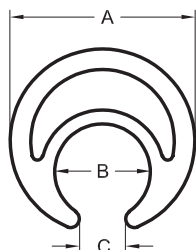

Wymiar Dimension Abmessung	Obwód Perimeter Abwicklung	Masa Weight Gewicht	Nr matrycy Number of die Werkzeug Nr.
A x B x C	mm	kg/m	
27 x 14 x 6,7	117,56	0,728	M1.90183
27 x 14 x 7	116,64	0,592	M1.90428

Wymiar Dimension Abmessung	Obwód Perimeter Abwicklung	Masa Weight Gewicht	Nr matrycy Number of die Werkzeug Nr.
A x B x C	mm	kg/m	
34 x 14,2 x 6,5	141,82	1,156	M1.90223

Wymiar Dimension Abmessung	Obwód Perimeter Abwicklung	Masa Weight Gewicht	Nr matrycy Number of die Werkzeug Nr.
A x B x C	mm	kg/m	
165 x 25 x 7	393,81	1,657	M1.90184

2.5. Profile elewacyjne

Elevation profiles | Elevationsprofile

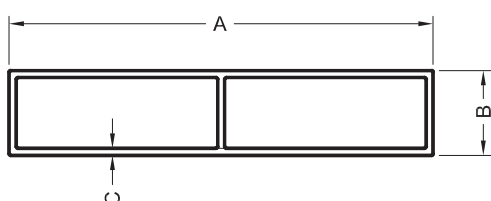
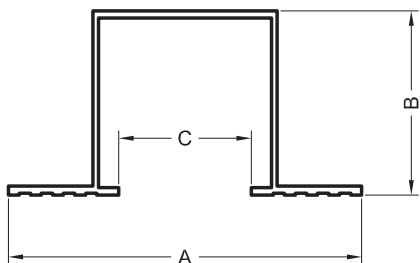

Wymiar Dimension Abmessung	Obwód Perimeter Abwicklung	Masa Weight Gewicht	Nr matrycy Number of die Werkzeug Nr.
A x B x C	mm	kg/m	
96 x 50 x 36	419,34	0,971	M1.90013

Wymiar Dimension Abmessung	Obwód Perimeter Abwicklung	Masa Weight Gewicht	Nr matrycy Number of die Werkzeug Nr.
A x B x C	mm	kg/m	
90 x 18 x 1,5	215,49	0,912	M1.90103
200 x 20 x 2,0	439,14	2,419	M1.90381

2. Profile specjalne | Special sections | Sonderprofile

2.6. Profile fotowoltaiczne

Profiles for photovoltaics | Profile für die photovoltaik

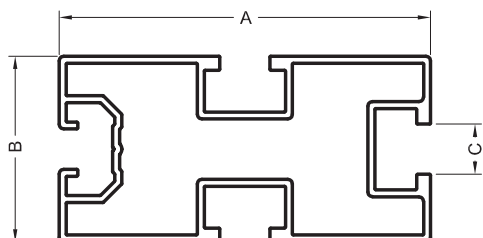

Wymiar Dimension Abmessung	Obwód Perimeter Abwicklung	Masa Weight Gewicht	Nr matrycy Number of die Werkzeug Nr.
A x B x C	mm	kg/m	
80 x 40 x 10,8	400,41	1,546	M1.90174

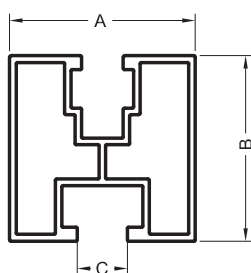

Wymiar Dimension Abmessung	Obwód Perimeter Abwicklung	Masa Weight Gewicht	Nr matrycy Number of die Werkzeug Nr.
A x B x C	mm	kg/m	
40 x 40 x 10,8	238,91	0,938	M1.90222
40 x 40 x 10,8	238,91	0,891	M1.90331

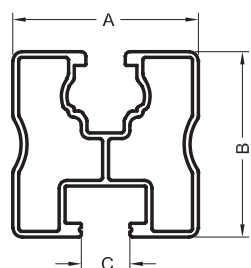

Wymiar Dimension Abmessung	Obwód Perimeter Abwicklung	Masa Weight Gewicht	Nr matrycy Number of die Werkzeug Nr.
A x B x C	mm	kg/m	
40 x 40 x 10,5	237,91	0,838	M1.90352

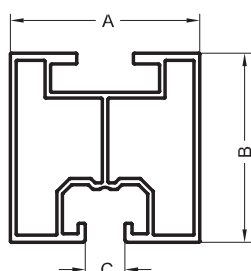

Wymiar Dimension Abmessung	Obwód Perimeter Abwicklung	Masa Weight Gewicht	Nr matrycy Number of die Werkzeug Nr.
A x B x C	mm	kg/m	
40 x 40 x 8,4	247,62	0,847	M1.90429

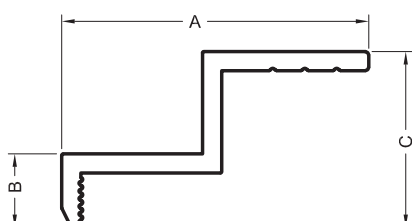

Wymiar Dimension Abmessung	Obwód Perimeter Abwicklung	Masa Weight Gewicht	Nr matrycy Number of die Werkzeug Nr.
A x B x C	mm	kg/m	
48 x 11,5 x 27,5	154,63	0,579	M1.90265
37,8 x 10,8 x 26,8	131,22	0,467	M1.90376

2. Profile specjalne | Special sections | Sonderprofile

2.6. Profile fotowoltaiczne

Profiles for photovoltaics | Profile für die photovoltaik

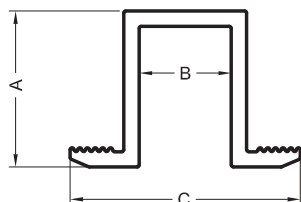

Wymiar Dimension Abmessung	Obwód Perimeter Abwicklung	Masa Weight Gewicht	Nr matrycy Number of die Werkzeug Nr.
A x B x C	mm	kg/m	
24,4 x 14,4 x 36	170,10	0,519	M1.90377

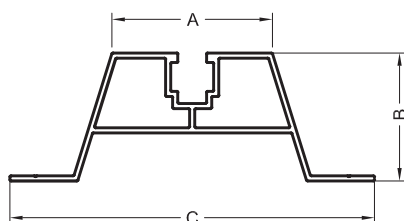

Wymiar Dimension Abmessung	Obwód Perimeter Abwicklung	Masa Weight Gewicht	Nr matrycy Number of die Werkzeug Nr.
A x B x C	mm	kg/m	
50 x 40 x 114	348,22	1,202	M1.90385
50 x 70 x 114	420,50	1,672	M1.90384

2.7. Profile do hal namiotowych

Profiles for tents | Zeltbauprofile

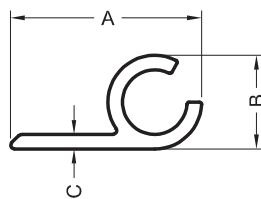

Wymiar Dimension Abmessung	Obwód Perimeter Abwicklung	Masa Weight Gewicht	Nr matrycy Number of die Werkzeug Nr.
A x B x C	mm	kg/m	
26,5 x 13 x 2	91,17	0,244	M1.90355

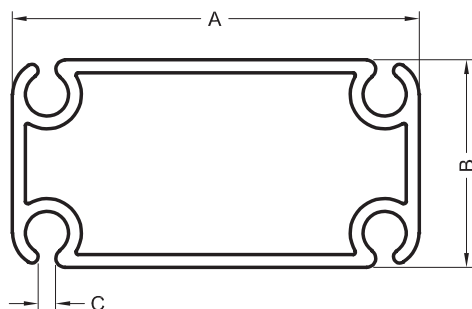

Wymiar Dimension Abmessung	Obwód Perimeter Abwicklung	Masa Weight Gewicht	Nr matrycy Number of die Werkzeug Nr.
A x B x C	mm	kg/m	
94 x 48 x 4	378,00	2,665	M1.90312
150 x 88 x 7	640,10	4,601	M1.90252

2. Profile specjalne | Special sections | Sonderprofile

2.8. Profile inne

Other profiles | Andere Profile

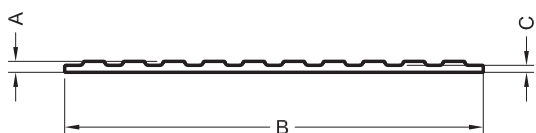

Wymiar Dimension Abmessung	Obwód Perimeter Abwicklung	Masa Weight Gewicht	Nr matrycy Number of die Werkzeug Nr.
A x B x C	mm	kg/m	
3 x 115,1 x 1,9	246,21	0,775	M1.90113

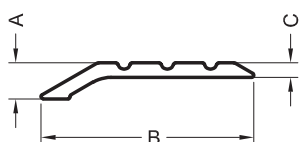

Wymiar Dimension Abmessung	Obwód Perimeter Abwicklung	Masa Weight Gewicht	Nr matrycy Number of die Werkzeug Nr.
A x B x C	mm	kg/m	
5 x 29,5 x 2	64,74	0,143	M1.90114

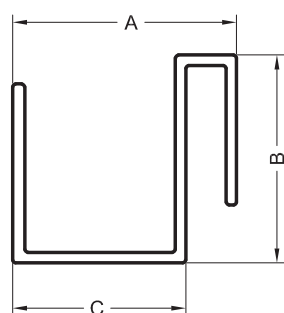

Wymiar Dimension Abmessung	Obwód Perimeter Abwicklung	Masa Weight Gewicht	Nr matrycy Number of die Werkzeug Nr.
A x B x C	mm	kg/m	
38,8 x 36 x 30	253,83	0,637	M1.90207

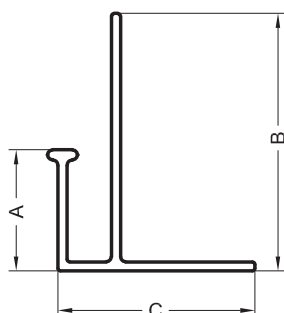

Wymiar Dimension Abmessung	Obwód Perimeter Abwicklung	Masa Weight Gewicht	Nr matrycy Number of die Werkzeug Nr.
A x B x C	mm	kg/m	
24 x 51 x 39	227,99	0,559	M1.90217

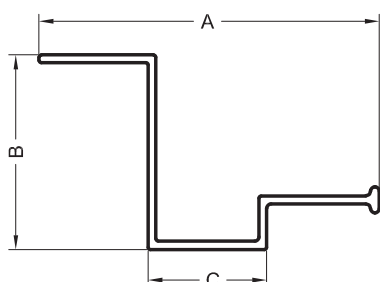

Wymiar Dimension Abmessung	Obwód Perimeter Abwicklung	Masa Weight Gewicht	Nr matrycy Number of die Werkzeug Nr.
A x B x C	mm	kg/m	
78,6 x 45 x 27,4	271,16	0,679	M1.90218

2. Profile specjalne | Special sections | Sonderprofile

2.8. Profile inne

Other profiles | Andere Profile

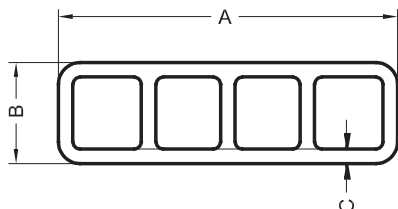

Wymiar Dimension Abmessung	Obwód Perimeter Abwicklung	Masa Weight Gewicht	Nr matrycy Number of die Werkzeug Nr.
A x B x C	mm	kg/m	
47 x 14 x 2	116,85	0,766	M1.90344

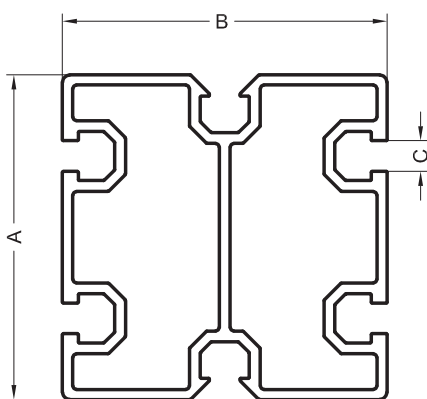

Wymiar Dimension Abmessung	Obwód Perimeter Abwicklung	Masa Weight Gewicht	Nr matrycy Number of die Werkzeug Nr.
A x B x C	mm	kg/m	
90 x 90 x 8,5	561,32	4,617	M1.90360

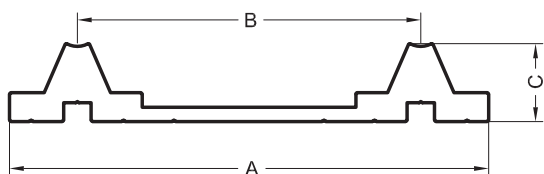

Wymiar Dimension Abmessung	Obwód Perimeter Abwicklung	Masa Weight Gewicht	Nr matrycy Number of die Werkzeug Nr.
A x B x C	mm	kg/m	
166 x 119 x 27	433,97	4,547	M1.90422

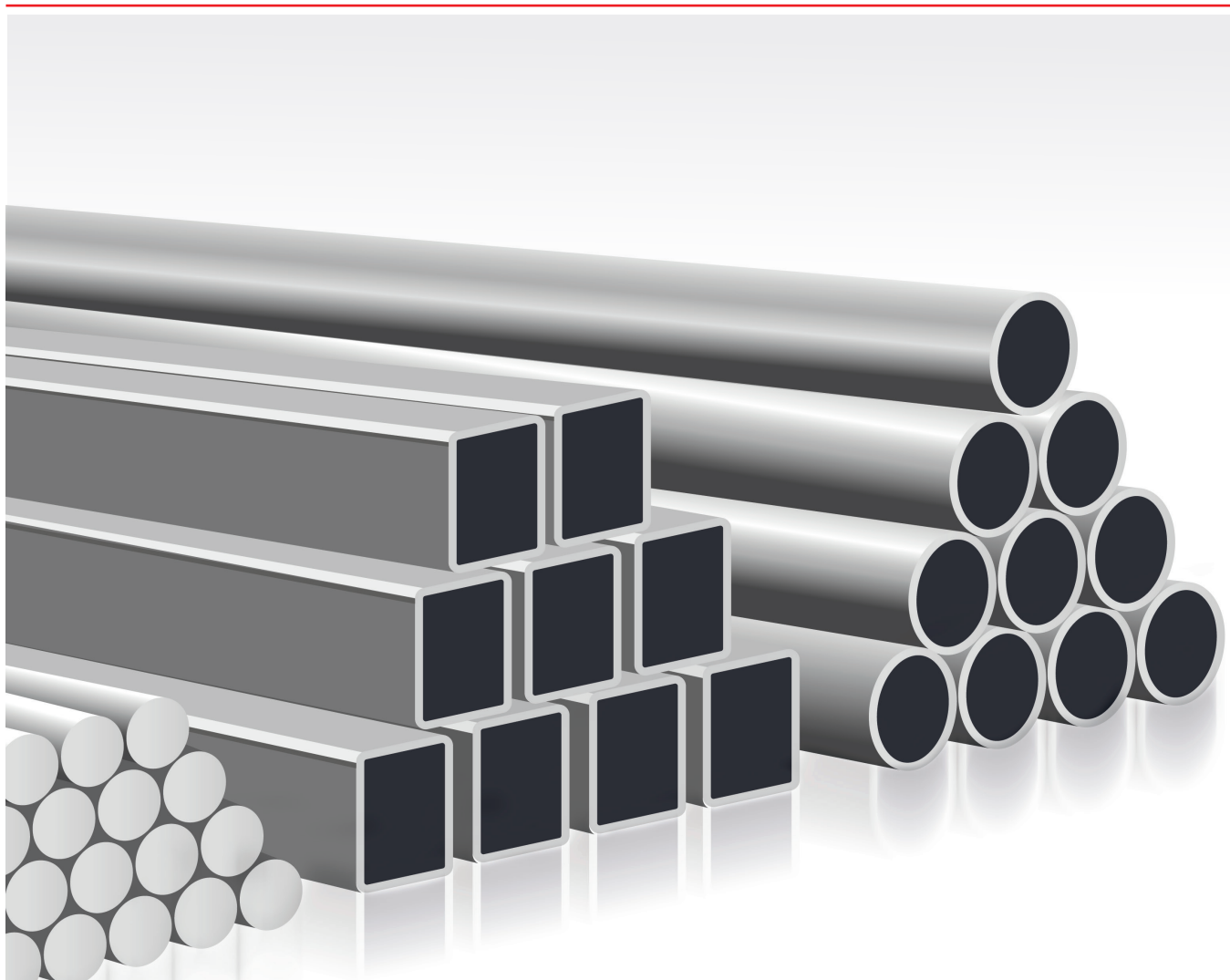

aliplast
aluminium extrusion

Aliplast Extrusion Sp. z o.o.
ul. Wacława Moritza 3
20-276 Lublin, Polska

Kontakt

t: +48 81 710 61 63
f: +48 81 745 50 31
e: extrusion@aliplast.pl

www.aliplastextrusion.pl



2023.02



www.corialis-group.com